

高清智能网络摄像机

HD Intelligent IP Camera

KEDACOM

快速安装指南

Quick Start Guide

一 前言

感谢您购买我司产品，如对本公司产品有疑问或需要，请随时和我们联系。

此内容（手册）的目的是确保用户正确使用本产品，以避免危险或财产损失。在使用产品之前，请认真阅读此手册并妥善保存以备日后参考。如果用户因没有按照以下安全说明，致使设备不能正常使用或损坏等情况，我司恕不负责，感谢您的配合。

二 安全使用注意事项

1. 电源要求

- 请在安装使用设备过程中，严格遵守当地各项电气安全规定。
- 请使用满足安全电压要求的电源，在设备运行之前检查供电电源是否正确。
- 请在安装配线时装入易于使用的断电设备，以便必要时进行紧急断电。
- 请保护电源软线免受踩踏或紧压，特别是在插头、电源插座和从装置引出的接点处。
- 请在断电状态下连接电源、告警、音频、RS485等线缆，严禁在设备上电的情况下连线。

2. 使用环境要求

- 请勿将摄像机对准强光（如灯光照明、太阳光等处）聚焦，否则容易引起过亮或漏光现象（这并非摄像机故障）也将影响摄像机寿命。
- 请在允许的湿度和温度范围内运输、使用和存储设备。
- 请勿将设备置于潮湿、多尘、极热、极冷、强电磁辐射或照明条件不稳定等场所。
- 请勿让任何液体流入设备，以免内部元件受损。
- 请勿阻挡设备附近的通风口，以免热量积蓄。
- 请在运送设备时，重新以出厂时的包装进行包装，或用同等品质的材质包装。
- 请勿在运输、储存及安装过程中重压、剧烈震动、浸泡设备。

工作环境	
工作电源	AC24V±10%/POE (802.3at)
功耗	24W Max
温度	-40°C~+70°C
湿度	10%~95% (无凝结)
海拔高度	-60m~3000m
大气压	86kPa~106kPa

3. 日常维护与保养

- 请勿直接接触设备发热部件，以免烫伤。
- 镜头沾染灰尘或油脂时，用棉布或镜头擦拭布擦拭。若遇污垢难以清除，蘸上少量镜片清洁液，自镜头中心向外旋转轻轻擦拭，直到干净为止。禁止使用有机溶剂（苯、酒精等）对镜头和护罩前脸进行除尘、清洁。
- 请不要以任何方式拆卸或修改产品。（对未经认可的修改或维修导致的问题，本公司不承担任何责任）。
- 如果设备工作不正常，请联系经销商或最近的服务中心。

4. 特别声明

- 本手册中的图示仅供参考，产品请以实物为准。
- 我们尽最大努力来保证本手册信息的正确性，如因升级等原因发生信息修改，恕不另行通知。
- 本手册能作为多个型号产品的使用指导，但并不一一列举每个产品的使用情况，请您根据实际产品自行对照。
- 本产品使用IPCSearch激活后方能使用，激活时请填写有效邮箱，方便找回密码。IPCSearch请至官网下载，下载地址：<https://www.kedacom.com/cn/softtools/index.jhtml>
- 为了提高产品网络使用的安全性，建议您设置高强度密码：密码长度必须达到8-16个字符，且至少由数字和字母或特殊字符中的两种或两种以上类型组合而成。请您定期更改用户名的密码，建议每3个月更新一次密码。如果设备在较高安全风险的环境中使用，建议每月或每周更新一次。请妥善保管好您的用户名与密码。
- 将本产品接入互联网需自担风险，包括但不限于产品可能遭受的网络攻击、黑客攻击、病毒感染等，本公司不对因此造成的产品工作异常、信息泄露等问题承担责任，本公司将及时为您提供产品相关技术支持。
- 如需获取最新文档，请至官网下载，官网地址www.kedacom.com。

三 外观及接口

外观尺寸

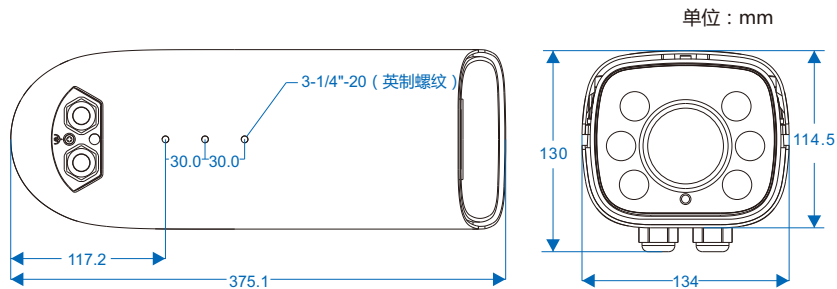

外观部件

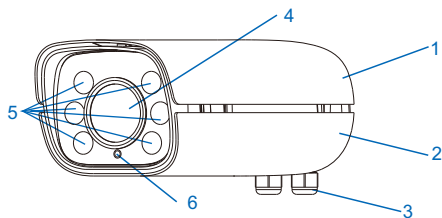

序号	部件名称
1	上盖
2	下盖
3	Pg头 (穿线)
4	镜头
5	6×补光灯
6	光敏

尾线



表1 线缆接口介绍

接口	接口名称	功能描述
1	用户线缆组合	包含告警输入/输出，音频输入/输出，RS485串口等
2	网络接口	连接交换机等网络接入设备
3	电源接口	连接AC24V电源
4	WIFI接口	连接WIFI天线
5	GPS接口	连接GPS天线

表2 用户线缆组合接口介绍

接口名称	序号	颜色	接口名称	功能描述
用户线缆组合	1	白	RS485_B	RS485串口，与外界设备交互控制，如控制第三方设备
	2	灰	RS485_A	
	5	绿/白	AUDIO_GND	音频接地
	6	绿	AUDIO_IN_2	音频输入接口，输入音频信号或进行语音对讲
	7	橙/白	AUDIO_GND	音频接地
	8	橙	AUDIO_IN_1	音频输入接口，输入音频信号或进行语音对讲
	9	黑/白	AUDIO_GND	音频接地
	10	粉红	AUDIO_OUT	音频输出接口，输出音频信号
	11	紫	ALARM_IN_GND	告警输入接地

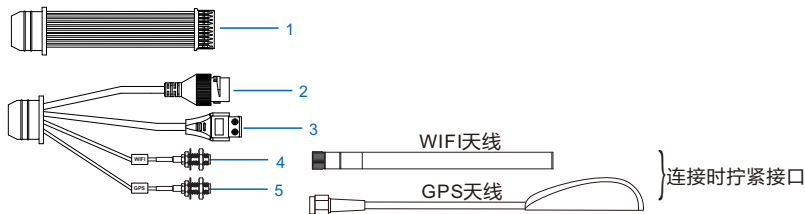
接口名称	序号	颜色	接口名称	功能描述
用户线缆组合	13	黄	ALARM_IN_2	告警输入接口，输入告警信号
	14	棕	ALARM_IN_1	
	15	白棕	ALARM_OUT_1A	告警输出接口，输出告警信号
	16	白红	ALARM_OUT_1B	

【说明】1) 告警输出ALARM_OUT_1A和ALARM_OUT_1B不分正负极，组成一路告警输出。

2) 两路告警输入 (ALARM_IN_1和ALARM_IN_2) 共用告警地线。

PG头

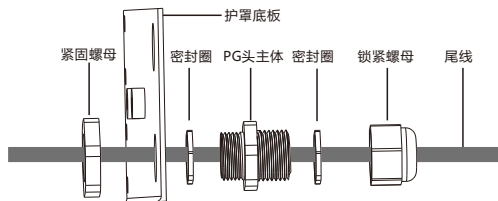

拆装方法：

- 1) 打开护罩，一手握住PG头主体，一手卡住紧固螺母，逆时针旋转PG头主体将护罩上的PG头拆下。
- 2) 逆时针旋转锁紧螺母将其拆下，将已经穿好金属包塑波纹的线缆依次穿入紧固螺母、PG头主体、锁紧螺母，然后顺时针拧紧锁紧螺母。

【说明】拆装过程中请勿丢弃密封圈，并确保不要漏装。

- 3) 将穿入线缆的PG头顺时针安装在护罩上，拧紧PG头，预留适当长度的线缆即可。
- 4) PG头底部和金属包塑波纹接触点，用防水胶带由上而下逆时针均匀缠绕，之后再顺时针均匀缠绕，做好防水、防尘处理。
- 5) 穿线完成后，盖好护罩上盖，以便将设备安装到支架上。

四 设备安装

安装注意事项

- 确认安装地点有容纳本产品及其安装结构件的足够空间。
- 请确保安装摄像机的墙面、横杆等的承受能力必须能支撑摄像机及其安装结构件重量的 8 倍。
- 没有限高通行的路段，建议摄像机安装高度不低于 5 米，减少摄像机被碰擦的风险。
- 施工期间禁止人员在摄像机下方 2 米内活动，并请配戴好安全帽等防护装备。

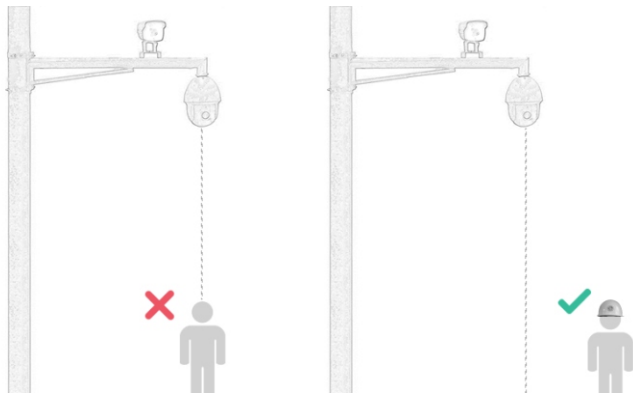

安装存储卡（可选，部分型号支持）

设备安装TF卡后支持图片告警抓拍和录像存储。TF卡安装步骤如图。

【说明】 TF卡容量最大支持256G，插入TF卡后，不建议对其进行热插拔。

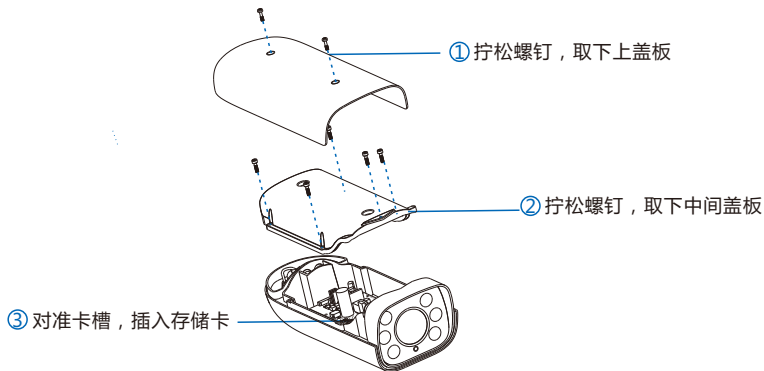

连接线缆

- 1) 按机身内线缆标签，对摄像机尾线做相应连接。
- 2) 穿线。线缆连接完成后，将线缆从PG头穿出。

【说明】 穿线时，建议将网线和电源线从不同的PG头穿出。

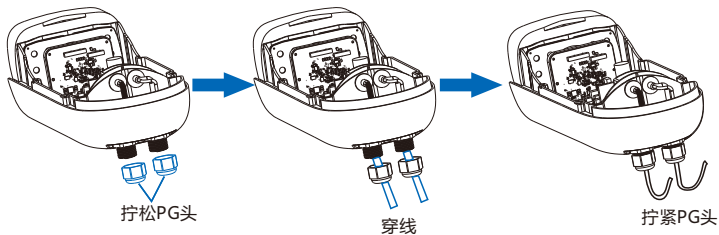

3) WIFI天线和GPS天线连接

WIFI天线接口在设备下方，连接时从包装箱中取出WIFI天线，将天线一端的接口与设备下方的接口对准并拧紧。

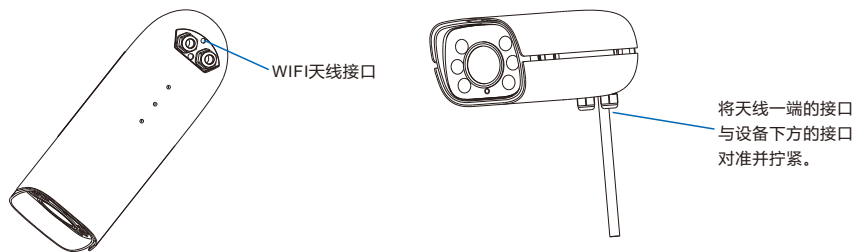

GPS天线接口由单独一根线缆引出。连接时，从包装箱中取出GPS天线，将设备引出的GPS接口与天线的接口对准并拧紧。GPS天线的磁铁用于固定天线，可以吸附在金属部件上。

【说明】请不要将GPS天线放置于被遮挡的区域，如天桥下，以免影响信号。

支架安装

摄像机支持横杆安装、吊装和壁装。横杆装、吊装、壁装支架为选配件，请根据需要进行选购。

1) 横杆安装

横杆安装需配合万向节，安装方法如下：

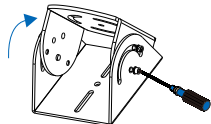

① 拧松万向节螺钉，调整万向节角度

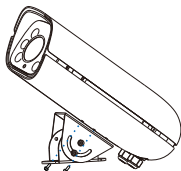

② 将万向节固定在设备底部的安装板上

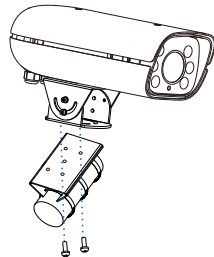

③ 将设备固定在横杆上

2) 吊装

我司选配吊装支架尺寸如下：

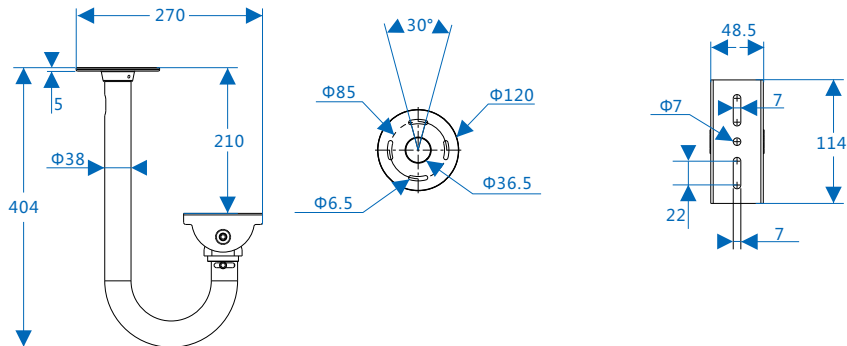

吊装安装方法如下：

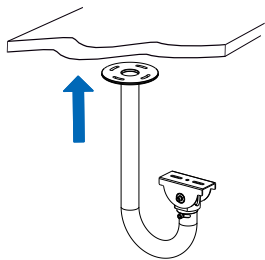

① 将吊装支架固定在天花板上

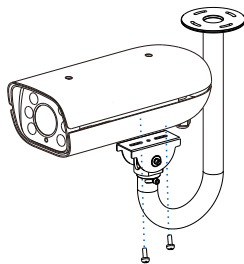

② 将设备固定在吊装支架上

五 登录客户端

1. 最低配置和系统环境

- 处理器：3.3GHz酷睿®i3系列及以上或相同性能的其他处理器
- RAM内存：4GB及以上
- 操作系统：WindowsXP操作系统或更高版本
- 浏览器（32位）：360浏览器，IE7.0及以上版本，Firefox（51.0及以下版本），Google Chrome（41.0及以下版本）
- DirectX：9.0c

2. 设备激活

第一次使用时请运行IPCSearch，在IPCSearch中将显示设备的IP地址、网关等信息。若IPC设备所接入的网络有DHCP服务，DHCP服务器将自动给IPC分配IP地址。

- 批量激活：在IPCSearch中选中设备，点击**批量处理**，在弹出的界面中设置admin用户的密码和找回密码时需要用的邮箱，点击**激活**按钮激活设备。设备将自动重启。
- 单个激活：在IPCSearch中选择设备，单击右键，选择**设备激活**。填写用户名、密码、找回密码时需要用到的邮箱。点击**激活**按钮激活设备。设备将自动重启。
- Web客户端激活：也可以通过Web客户端激活。将PC机与设备设为同一网段，登录Web界面。可在界面设置管理员密码和密码恢复邮箱，点击**激活**。

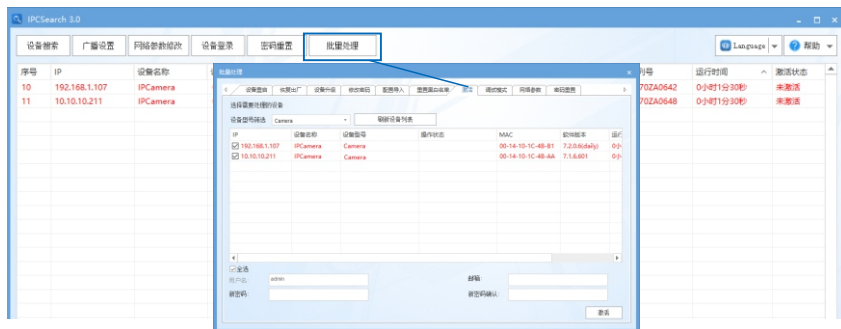

用户名

密码

确认密码

密码恢复邮箱

管理员密码丢失后通过此邮箱找回,请确保邮箱安全、有效

3. 修改设备IP

点击**修改网络参数**，在弹出的界面中配置网络参数。静态分配IP地址时，请选择自定义地址，填写以太网参数。修改参数配置，需要填写管理员用户用户名（admin）及激活设备时所设置的密码。完成IP配置后，设备将自动重启。

4. 登录设备

1) 在IPCSearch中双击设备或点击**登录设备**，输入用户名和密码，登录Web客户端。

登录

2) 登录成功后，下载并安装视频插件（IE内核浏览器）。

3) 进入客户端后，直接浏览图像。

【说明】不同型号，浏览界面略有差异，请以实际界面为准。更多客户端说明请参考客户端帮助文档。

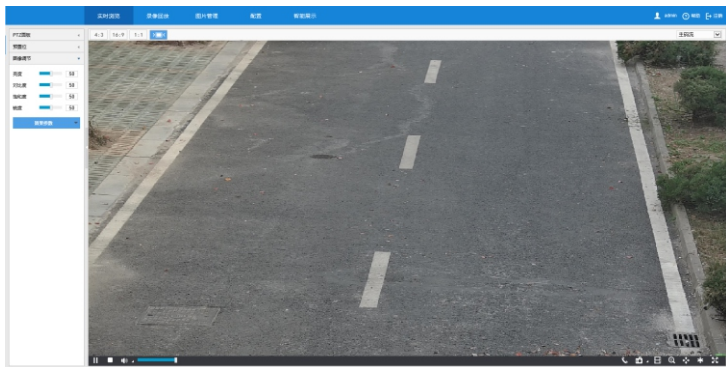

4) 设备安装TF卡后，需确认TF卡是否已格式化，进入**配置>存储>存储管理**界面查看TF卡状态。如果状态显示为未格式化，需要勾选TF卡，点击**格式化**按钮进行格式化，才可正常使用。格式化过程支持分区，可用于存储录像和图片。



六 快速配置

1. 安装配置

进入**智能展示>智能配置>安装配置**界面，点击**安装示意图**，参考示意图进行安装配置，步骤如下：

- 1) 安装检查。根据实际的安装环境，并参考架设参数表（详见附录A），选择适宜的安装高度安装摄像机。安装完成后，点击**显示倾斜角**，可在查看当前摄像机的垂直和水平角度，将摄像机调整至合适的倾斜角度。

【说明】安装时，应确保摄像机的安装高度为2m~6m，且正对抓拍区域；垂直角度范围为 10° ~ 15° ，推荐垂直角度为 13° ；水平角度不得大于 5° ；监控距离约为安装高度的3~4倍。

- 2) 视野调节。勾选**目标像素测量**，可显示画面中人员的瞳孔间距。点击**拉远**或**拉近**按钮，调整视野，确保人员脸部处于画面中心位置时，瞳孔间距不小于40像素。
- 3) 对焦。摄像机默认为自动聚焦模式，当且仅当自动聚焦无法获得清晰的图像时，才需进行手动对焦。点击**打开清晰度调节**，画面出现一个红色框，框内显示清晰度系数。该系数越大，清晰度越高。点击**聚远**、**聚近**或**自动聚焦**按钮使镜头对焦，清晰度系数随之变化，清晰度系数最大时表明达到最佳对焦位置。

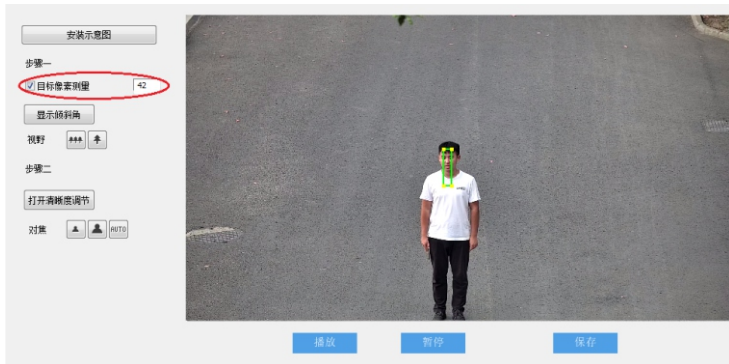

【说明】分辨率大于200W像素的摄像机，需手动绘制聚焦区域。可在预绘制区域中布置人员或放置纹理丰富的物体，以提高对焦精度。进入**配置>摄像机>图像>聚焦**，点击**开始绘制**，在画面底部位置绘制重点聚焦区域，绘制完成后，点击**停止绘制**；再点击**设置**，进行自动聚焦；完成后，在聚焦模式中选择**镜头锁定**，锁定当前配置。

图像效果



- 【注意】**
- 1) 安装时，可适当调整摄像机的安装高度和角度，以确保摄像机视野中心对准重点抓拍区域。摄像机不得倾斜，需确保画面中人员姿态端正。
 - 2) 清晰度显示功能仅在编码格式为H.264或H.265时有效。调节清晰度时，建议用一个纹理丰富的物品做调节板，如报纸等。
 - 3) 安装配置完成后，点击**保存**，设置才能生效，同时锁定摄像机的焦距。若在其他界面调节焦距，5分钟之后摄像机自动恢复到锁定状态。
 - 4) 镜头参数调试完成后，避免误操作，可对镜头进行锁定，进入**配置>摄像机>图像>聚焦>聚焦模式**界面，下拉菜单选择**镜头锁定**，锁定状态，镜头参数不可调节，如需重新调试，可在下拉菜单中选择其他模式，比如自动聚焦（单次），解除锁定。

2. 标定配置

进入**智能展示>智能配置>标定配置**界面，可进行优选区域配置。未启用优选区域时，摄像机默认为全画面选优；启用后，当目标经过设置的优选区域后，摄像机将优先输出该区域内抓拍的最佳快照。实际场景中，尤其是夜晚补光灯仅能覆盖部分区域的情况下，需进行优选区域配置，步骤如下：

- 1) 勾选**启用优选区域**，显示优选区域，默认为画面从上至下1/2~3/4处。
- 2) 点击优选区域框，拖动框体四角的黄色端点，可调整优选区域的长和宽；长按蓝色边框，拖动优选区域框体，可将其调整到合适的位置。
- 3) 点击**保存**，设置生效。

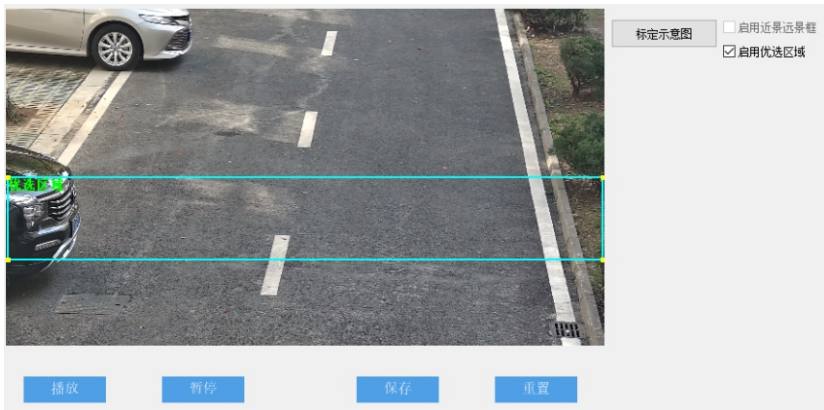

附录A：架设参数表

摄像机高度： H	监控距离范围： L	摄像机角度 范围：a	最佳摄像机 角度：a	最佳监控宽度		
				200W像素	600W像素	800W像素
2m	3m~8m	10°~15°	13°	4m	5m	6m
2.5m	4m~10m					
3m	6m~12m					
3.5m	8m~14m					
4m	10m~17m					
5m	16m~23m					
6m	18m~25m					

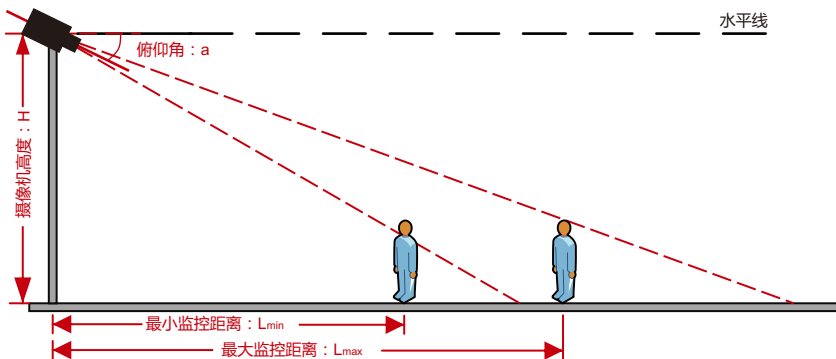

附录B：AC24V线径与传输距离关系表

当线径大小一定，AC 24V电压损耗率低于10%时，不同传输功率推荐的最大传输距离。（对于AC 24V交流供电设备，其最大允许电压损耗率为10%。下面表格中所用线缆均为铜线，铜的电阻率为 $\rho = 0.0175\Omega \cdot \text{mm}^2/\text{m}$ ）

距离 m(feet)	线径 mm	0.8 (20AWG)	1.0(18AWG)	1.25(16AWG)	2.0(12AWG)
		功率W			
5		122 (401)	194 (636)	307 (1008)	781 (2562)
10		61 (201)	97 (318)	154 (504)	391 (1281)
15		41 (134)	65 (212)	102 (336)	260 (854)
20		31 (100)	48 (159)	77 (252)	195 (641)
25		24 (80)	39 (127)	61 (202)	156 (512)
30		20 (67)	32 (106)	51 (168)	130 (427)
35		17 (57)	28 (91)	44 (144)	112 (366)
40		15 (50)	24 (79)	38 (126)	98 (320)
45		14 (45)	22 (71)	34 (112)	87 (285)
50		12 (40)	19 (64)	31 (101)	78 (256)
55		11 (36)	18 (58)	28 (92)	71 (233)
60		10 (33)	16 (53)	26 (84)	65 (214)
65		9 (31)	15 (49)	24 (78)	60 (197)
70		9 (29)	14 (45)	22 (72)	56 (183)
75		8 (27)	13 (42)	20 (67)	52 (171)
80		8 (25)	12 (40)	19 (63)	49 (160)
85		7 (23)	11 (37)	18 (59)	46 (151)
90		7 (22)	11 (35)	17 (56)	43 (142)
95		6 (21)	10 (33)	16 (53)	41 (135)
100		6 (20)	10 (32)	15 (50)	39 (128)

【说明】 线径要求适用于单根、实心、圆形的铜线，多股绞线的电缆AWG值是由所有线的总横截面积决定。

保修说明

本保修卡适用于您购买的本公司系列产品。

1.免费保修期一年（仅限中国大陆地区，中国大陆以外地区请参考英文说明）。

2.凡保修期内，由于本产品自身引起的故障，请与公司售后服务部联系。

3.保修时我们将使用您的保修卡信息，请认真填写。

4.以下情况，属于有偿保修范围：

- 人为原因造成的设备故障
- 因使用环境不符合本产品要求造成的故障
- 因不可抗力造成的产品损坏
- 无保修卡
- 已过免费保修期

用户信息

用户名称：

详细地址：

传真：

电话：

邮箱：

邮编：

产品名称：

产品型号：

购买日期：

I Preface

Thank you for purchasing our product. If there are any questions, or requests, please do not hesitate to contact us.

The intention of writing this Guide is to ensure that user can use the product correctly to avoid danger or property loss. Please read this Guide carefully before using, and keep it properly for future reference. If the product cannot work normally or is damaged because the user does not follow the safety instructions, we shall not assume any responsibility. Your cooperation will be highly appreciated.

II Safety Instruction

1. Power Supply

- During installing and using the device, please follow local electrical safety regulations strictly.
- Please use power supply in the safe voltage range of our product. Make sure the power supply is correct before running the device.
- Please install an easy-to-use breaker during installation and wiring in case it is necessary to make an emergency break.
- Please prevent the power cord from being trampled or pressed especially the plug, socket and the connecting part led out from the device.
- Please connect cables of power, alarm, audio and RS-485 with the power off. Hot-line wiring is not allowed.

2. Working Environment

- Do not focus the camera lens on strong light such as the sun or incandescent lamp; otherwise the strong light will cause overexposure or light leak (not camera malfunction), which may shorten camera lifetime.
- Please transport, use and store the device within defined humidity and temperature ranges.
- Do not expose it in damp, dusty, extremely hot or cold places or places with intense electromagnetic radiation or with unstable lighting.
- Keep the camera away from water or any liquid to avoid damage to internal components.
- To avoid heat accumulation, please do not block the ventilation around the device.
- While shipping the camera, pack it in the factory packing or use materials with equivalent quality.
- When shipping, storing and installing the device, try to prevent it from damages caused by pressure, violent vibration and soaking.

Operating Environment	
Voltage	AC 24V±10% / PoE (802.3at)
Power Consumption	24W Max
Temperature	-40°C ~ +70°C
Humidity	10%~95% (non-condensing)
Altitude	-60m~3000m
Pressure	86kPa~106kPa

3. Daily Maintenance

- Do not touch the heat component of the device directly to avoid empyrosis.
- When the lens is contaminated by dust or grease, use cotton cloth or lens clean cloth to wipe it off. When it is hard to clean, dip some lens cleanser and wipe gently and rotate outward from the middle until it is clean. Never apply any organic solvent with ethanol or benzene to clean the lens and housing.
- Do not disassemble or repair the device in any way by yourself. We shall not assume any responsibility for problems caused by unauthorized repair or maintenance.
- If the product does not work properly, please contact your dealer or the nearest service center.

4. Special Statement

- The product appearance is subject to the actual device. Pictures in this Guide are for your reference only.
- Every effort has been made to ensure the accuracy and validity of this Guide. Any update of this Guide caused by version upgrade is subject to change without notice.
- This Guide is made for multiple models but it will not illustrate all models one by one. Please refer to it according to the actual products you are using.
- This device can be used after being activated through IPCSearch. During activation please fill a valid email address for finding back the password. You can download IPCSearch from our website, address: <https://www.kedacom.com/cn/softtools/index.jhtml>
- For safety's concern, it is strongly recommended that you set a strong password which is composed of at least 2 kinds of the following, digits, case-sensitive letters or specific symbols, and whose length ranges from 8 to 16 bits. Please modify the password periodically and once every 3 months is recommended. If the device is used in highly risky environment, suggest modifying the password monthly or weekly. Please keep your user name and password safe.
- You should be responsible for all risks of accessing the camera to the Internet, including but not limited to possible cyber-attack, hacking attack, virus infection and etc. This company is not responsible for product failures and information disclosure caused thereby, but will provide timely technical support for the camera
- For the latest files, please download from our website www.kedacom.com.

III Appearance and Interface

Dimensions

Unit: mm

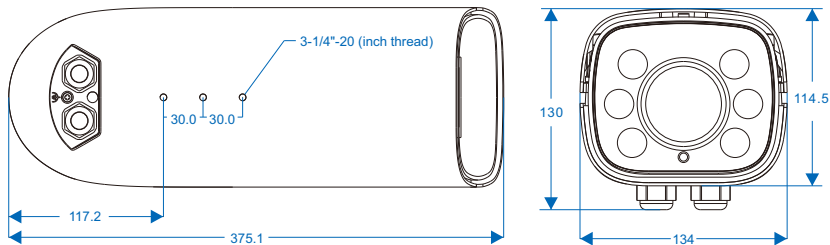

Components

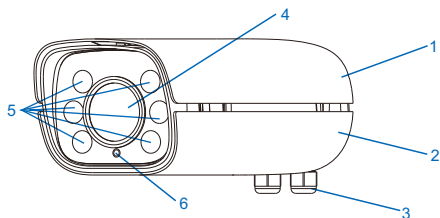

No.	Component
1	Upper Cover
2	Lower Cover
3	PG Head (thread wire)
4	Lens
5	6 x Fill Light
6	Photo-resistor

Buttcock Line

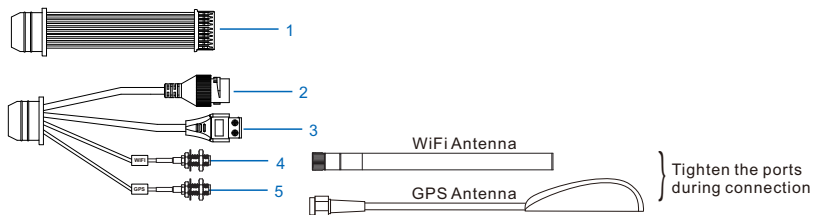

Table 1 Wiring Interface

No.	Interface Name	Function
1	User cable group	Including alarm in / out, audio in / out, RS-485 serial port and etc.
2	Network port	Connect to network access devices like a switch
3	Power supply	Connect to power supply of AC24V
4	WiFi port	Connect to WiFi antenna
5	GPS port	Connect to GPS antenna

Table 2 User Cable Group Interface

Interface	No.	Color	Name	Function
User Cable Group	1	White	RS485-B	RS-485 serial port to control peripheral devices such as third-party device
	2	Grey	RS485-A	
	5	Green/White	AUDIO GND	Audio grounding
	6	Green	AUDIO_IN_2	Audio input port for inputting audio signal or intercom
	7	Orange/White	AUDIO GND	Audio grounding
	8	Orange	AUDIO_IN_1	Audio input port for inputting audio signal or intercom
	9	Black/White	AUDIO GND	Audio grounding
	10	Pink	AUDIO OUT	Audio output port for outputting audio signal
	11	Purple	ALARM_IN_GND	Alarm input grounding
	13	Yellow	ALARM_IN_2	Alarm input port for inputting alarm signal
	14	Brown	ALARM_IN_1	
	15	White/Brown	ALARM_OUT_1A	Alarm output port for outputting alarm signal
	16	White/Red	ALARM_OUT_1B	

[Note]:

- 1) Alarm output ALARM_OUT 1A and ALARM_OUT 1B are regardless of positive and negative polarities and they form a group of alarm output.
- 2) The ALARM_IN_1 and ALARM_IN_2 wires share the alarm grounding wire.

PG Head

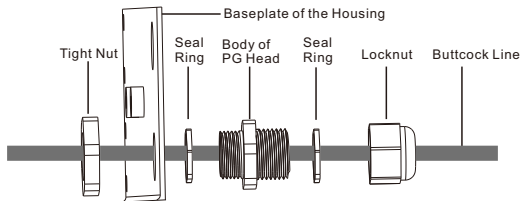

Disassembling and Assembling:

- 1) Open the housing, hold the body of PG head with one hand and steady the tight nut with another hand. Rotate the body of PG head anti-clockwise and take it down from the housing.
 - 2) Rotate the locknut anti-clockwise and take it down. Thread the wires that have threaded through the metal-covered corrugated cable through the tight nut, the body of PG head and the locknut in order, and then tighten the locknut clockwise.
- [Note] During disassembling and assembling, do not discard the seal ring and make sure it is in.
- 3) Install the PG head that has threaded through the wires onto the housing and make it tight with certain length of wires reserved.
 - 4) For the connecting point at the bottom of the PG head with the metal-covered corrugated cable, bind it evenly anti-clockwise from top to bottom with waterproof adhesive tape, and then bind it evenly clockwise. Make good waterproof and dustproof treatment to it.
 - 5) After finish threading wires, cover the upper cover of the housing so as to mount it onto the bracket.

IV Installation

1. Safety Instructions

- Make sure there is enough space for mounting the camera and its accessories.
- Make sure the wall or cross-bar can bear the weight as heavy as 8 times of the total weight of the camera and the accessories.
- On roads without height limits, the suggested installation height of the camera should be higher than 5m so as to reduce friction to the camera.
- During installation, no man shall be allowed to move around in 2m under the camera, and all men should wear a safety helmet.

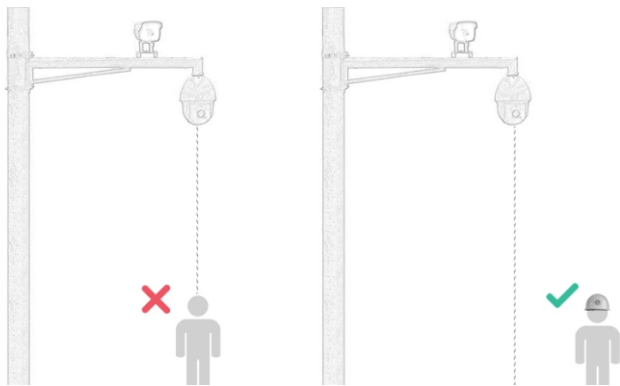

2. Install Storage Card (Optional, some models support)

Install a storage card in the camera to enable alarm snapshot and video recording. Installation steps are shown in the following picture.

[Note]: The max supported memory of TF card is 256G. After the TF card is inserted, hot-swapping is not recommended.

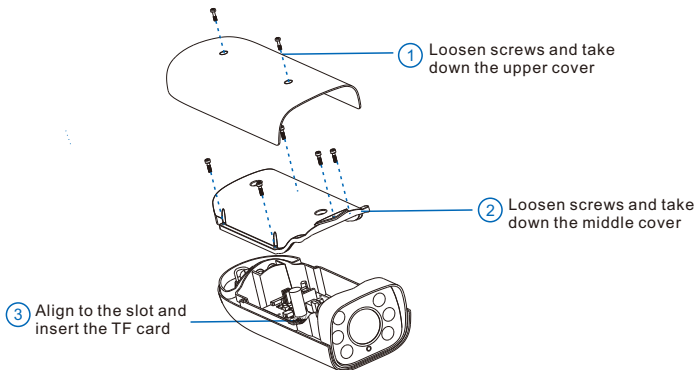

3. Connect Cables

- 1) Connect the buttock lines of the camera according to the tags on the wires.
- 2) Thread wires. After finish wire connections, thread the wires out through the PG head.

[Note] When threading wires, suggest threading the network cable and the power cord from different PG heads.

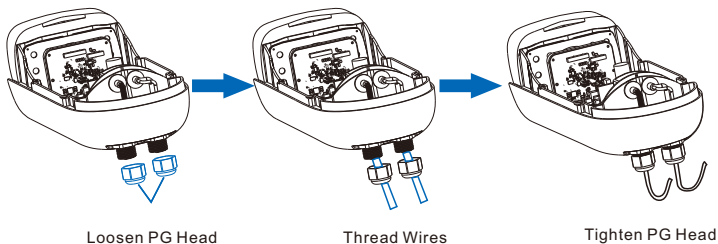

3) Connect WiFi antenna and GPS antenna

The WiFi antenna is at the bottom of the device. Take out the WiFi antenna from the packing, align the port at one end of the antenna to that at the bottom of the device and make it tight.



GPS antenna port is lead out by a single cable. Take out the GPS antenna, align the port on the antenna to the GPS port lead out from the device and make it tight. The magnetic iron on the GPS antenna is used to fix the antenna on metal parts.

[Note] Please do not put the GPS antenna at shielded areas such as under the overbridge, otherwise the signal of it may be affected.

4. Bracket Mount

The camera supports cross-bar mount, pendent bracket mount and wall bracket mount, the brackets of which are all optional. Please purchase separately if necessary.

1) Cross-Bar Mount

Cross-bar mount needs a cardan joint, the steps of which are as follows:

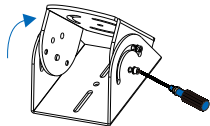

- ① Loosen the screws on the cardan joint to adjust its direction

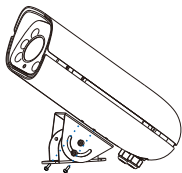

- ② Fix the cardan joint onto the baseplate at the bottom of the device

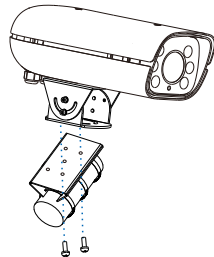

- ③ Fix the device onto the cross-bar

2) Pendant Bracket Mount

Dimensions of the optional pendant bracket of this company:

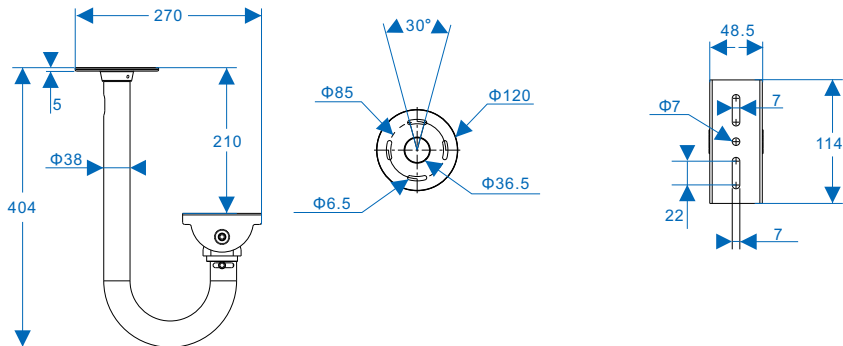

The steps of pendant bracket mount:

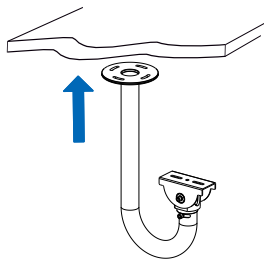

- 1 Fix the pendant bracket on the ceiling

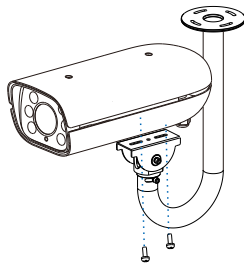

- 2 Fix the device onto the pendant bracket

3) Wall Bracket Mount

Dimensions of the optional wall bracket of this company:

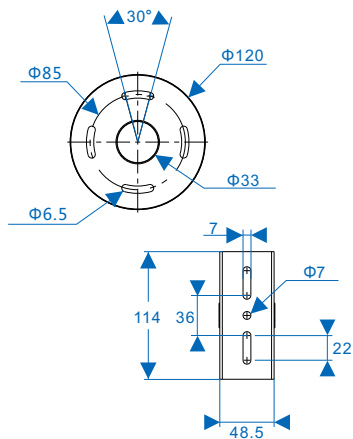
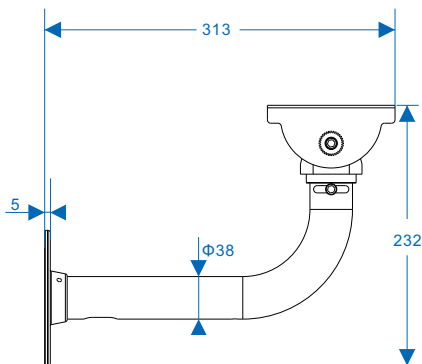

The steps of wall bracket mount:

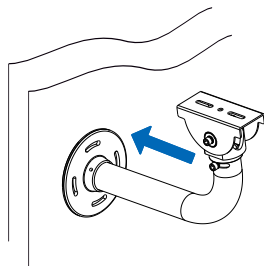

- 1 Fix the wall bracket on the wall

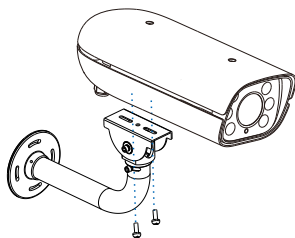

- 2 Fix the device onto the wall bracket

V Login to Web Client

1. Minimum System Configurations and Requirements

- Processor: 3.3 GHz CORE®i3 series or other equivalent processors
- RAM Memory: 4GB or above
- Operating System: Windows XP or newer version
- Browser (32 bits): 360 browser, IE7.0 or newer, Firefox (51.0 and lower versions), Google Chrome (41.0 and lower versions)
- DirectX : 9.0c

2. Device Activation

When using the device for the first time, IPCSearch will display the device IP address, gateway and etc. If the network provides DHCP service, DHCP server will assign IP for the camera automatically.

- Batch: Select the device and click "**Batch processing**". In the popup interface, set admin user's password and the email address to find back the password. Click "**Activate**" and wait for rebooting.
- Individual: Select the device from IPCSearch and right click to select "**Activate**". Fill admin user name and password and the e-mail address to find back the password. Click "**Activate**" and wait for rebooting.
- Web client: the device can also be activated through the web client. Set PC and the device in the same network segment and login to the web. User can set admin password and password reset email on the interface and click "**Activate**".

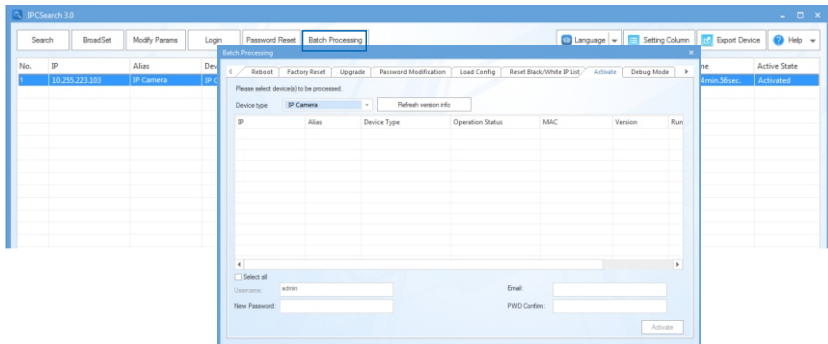

Login

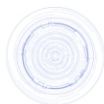

admin

admin

Weak Strong

Please choose a password with 8-16 characters. Your password must also contain two or more combinations of upper and lowercase letters, numbers, and symbols.

admin

admin

When admin's password gets lost, find it back through this email. Make sure this email address is safe and valid.

Active

3. Modify Device IP Address

Click **"Modify Params"** and set the network parameters. When configuring a static IP for the camera, please check **"Custom device address (Close DHCP)"** and fill the Ethernet parameter. During the modification, the user name (admin) and the password set before activation should be entered. After configuration, the camera will reboot automatically.

4. Login to the Device

- 1) Double click the device in IPCSearch or click **"Login"**. Enter user name and password to login the web client.

Login

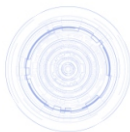

admin

admin

Login

- 2) After login, download and install the plug-in (IE Kernal browser).
- 3) Re-login to the web client and view live video directly.

[Note]: Interface of different models may differ. Please subject to the actual product. Please refer to the *Help* file for detailed explanation.

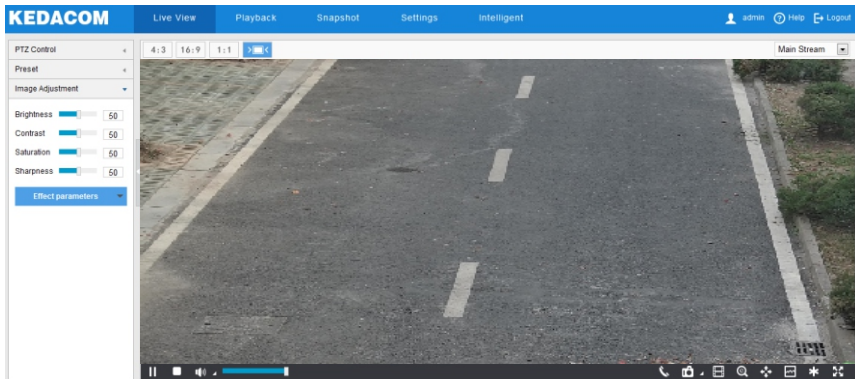

- 4) After installing the TF card, you need to confirm if the TF card has been formatted. Go to **Settings > Storage > Storage Management** to view TF card status. If it is unformatted, select the TF card and click "**Formatting**" to format it and it will work normally. The formatting supports partitioning to store videos and pictures.

Storage Management

Disk Full Strategy:

Storage Device List Formatting

Disk ID	Capacity	Remaining Space	Status	Type	Attribute	Progress
<input type="checkbox"/> 1	0M	0M	Does not Exist	Local External	Read-write	

Snapshot

Event	Scheduled	Alarming
Local storage	<input checked="" type="checkbox"/>	<input checked="" type="checkbox"/>
FTP	<input type="checkbox"/>	<input type="checkbox"/>

VI Quick Settings

1. Installation Configuration

Go to **Intelligent > Settings > Install**. Click **"Installation Diagram"** and configure according to the diagram, steps as follows:

- 1) Installation examination. Select proper installation height for the camera according to actual installation environment and Appendix A: Reference of Installation Parameters.

[Note] During installation, make sure the installation height of the camera is in the range of 2m ~ 6m and the lens faces rightly to the surveillance area; the tilt angle range is 10° ~ 15°, and 13° is recommended; the pan angle should be within 5°; the surveillance distance is about 3 ~ 4 times of the installation height.

- 2) Adjust camera field of view. Select **"Object Pixel Measure"** to show the interpupillary distance (IPD) of the person in the picture. Click icons of **"Zoom in"** or **"Zoom out"** to adjust the field of view and make sure the person's face is in the center of the picture and the IPD is no less than 40 pixels. Click **"Save"** to validate settings.
- 3) Focusing. The default focus mode of the camera is auto. Only when auto focusing cannot obtain clear images should user focus manually. Click **"Open Clarity Adjust"** and a red frame will display in the picture, showing the clarity coefficient. The larger the coefficient is, the higher the clarity will be. Click icons of **"Focus far"**, **"Focus near"** and **"Auto focus"** to make the lens focus and the clarity coefficient will change accordingly. When the coefficient comes to the max, it means the camera has reached the best focus position.

The screenshot displays the 'Installation Diagram' configuration window. On the left, there is a control panel with the following elements:

- A button labeled 'Installation Diagram'.
- 'Step 1' section:
 - A checked checkbox for 'Object Pixel Measure' with a value of '41'.
 - A 'Show Angle' button.
 - 'Zoom' controls with '+' and '-' icons.
- 'Step 2' section:
 - An 'Open Clarity Adjust' button.
 - 'Focus' controls with icons for 'Focus Far', 'Focus Near', and 'AUTO'.

The main area shows a live camera feed of a person standing on a paved surface. A green bounding box is drawn around the person's face, and a yellow vertical line indicates the interpupillary distance (IPD). At the bottom of the interface are three buttons: 'Play', 'Pause', and 'Save'.

[Note]: When the camera resolution is above 2.0 MP, you need to edit the focus area manually. You can arrange a person or put a richly-textured object in the edit area so as to improve focus accuracy. Go to **Settings > Camera > Image > Focus**, and click **"Edit"** to edit key focusing area at the bottom of the image. After finish editing, click **"Stop Editing"**. Click **"Setting"** to focus automatically and select **"Camera Lock"** from the dropdown list of "Focus Mode" to lock current settings.

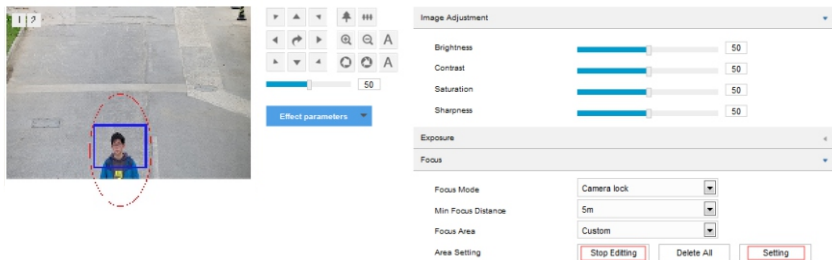

[Attention]:

- 1) During installation, you can adjust camera installation height and angle properly to make sure the camera lens is facing rightly to the key surveillance area. The camera cannot be slanted so as to make sure the person in the picture stands upright.
- 2) The clarity display function is available when the encoding format is H.264 or H.265. When adjusting image clarity, suggest using a richly-textured object as the adjustment board, such as newspaper.
- 3) After finishing installation configuration, click **"Save"** to validate settings and meanwhile lock the camera focal length. If you configure the camera focal length on other interfaces, the camera will restore to locking status automatically in 5 minutes.
- 4) After finishing lens adjustment, to avoid misoperation, lock the lens parameters by going to **Settings > Camera > Image > Focus > Focus Mode** and select "Camera Lock" from the dropdown list. If you want to re-adjust the lens, select another mode from the dropdown list to unlock lens parameters.

2. Calibration

Go to **Intelligent > Settings > Calibration** and configure the prior area. When "Enable Prior Area Flag" is unselected, the default prior area of the camera is full area; after selecting "Enable Prior Area Flag", when an object enters the prior area, the camera will output the optimum snapshots in this area first. In actual scenes, especially when the supplementary light at night can only cover partial area, prior area configuration is necessary. The configuration steps are as follows:

- 1) Select **"Enable Prior Area Flag"** to display the prior area. The default prior area is 1/2 to 3/4 part from the top of the image.
- 2) Click the prior area frame and drag the yellow points at the corners to adjust the length and width of the area; long-press on the blue lines of the frame and drag the frame to move it to a proper position.
- 3) Click **"Save"** to validate settings.

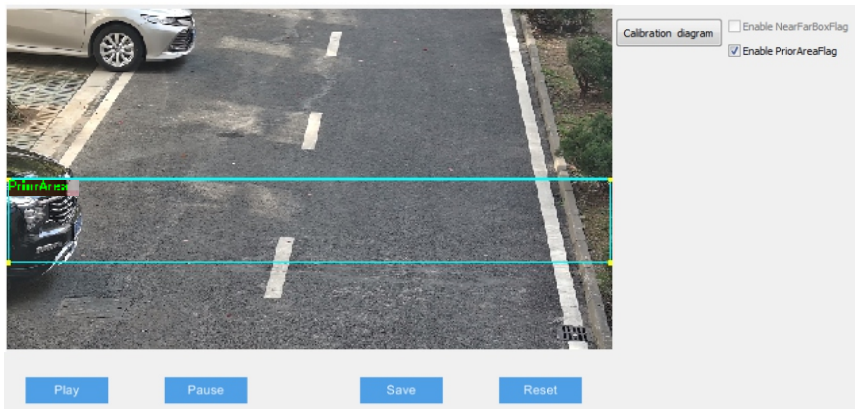

Appendix A: Reference of Installation Parameters

Camera Height: H	Surveillance Distance: L	Camera Angle of Pitch: a	Optimum Camera Angle: a	Optimum Surveillance Width		
				2.0 MP	6.0 MP	8.0 MP
2m	3m~8m	10°~15°	13°	4m	5m	6m
2.5m	4m~10m					
3m	6m~12m					
3.5m	8m~14m					
4m	10m~17m					
5m	16m~23m					
6m	18m~25m					

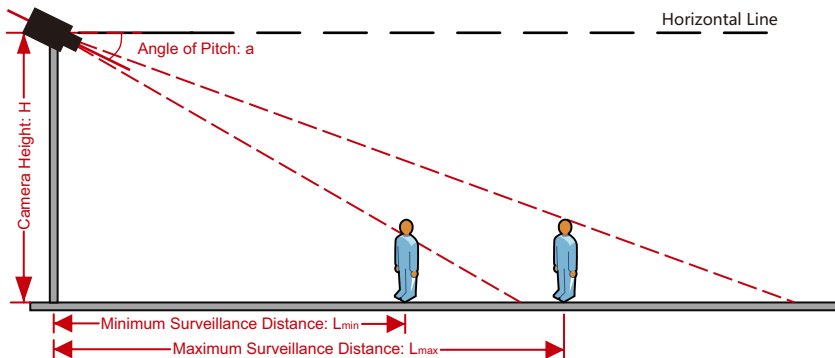

Appendix B: AC24V Wire Diameter VS. Transmission Distance

The recommended max transmission distance when the wire diameter is certain and the AC24V voltage loss rate is less than 10%

(For AC24V powered devices, the maximum allowed voltage loss rate is 10%. All the wires in the following table are cooper wires, whose electrical resistivity is $\rho = 0.0175\Omega \cdot \text{mm}^2/\text{m}$)

Distance m (feet) Power W	Diameter mm 0.8 (20AWG)	1.0(18AWG)	1.25(16AWG)	2.0(12AWG)
5	122 (401)	194 (636)	307 (1008)	781 (2562)
10	61 (201)	97 (318)	154 (504)	391 (1281)
15	41 (134)	65 (212)	102 (336)	260 (854)
20	31 (100)	48 (159)	77 (252)	195 (641)
25	24 (80)	39 (127)	61 (202)	156 (512)
30	20 (67)	32 (106)	51 (168)	130 (427)
35	17 (57)	28 (91)	44 (144)	112 (366)
40	15 (50)	24 (79)	38 (126)	98 (320)
45	14 (45)	22 (71)	34 (112)	87 (285)
50	12 (40)	19 (64)	31 (101)	78 (256)
55	11 (36)	18 (58)	28 (92)	71 (233)
60	10 (33)	16 (53)	26 (84)	65 (214)
65	9 (31)	15 (49)	24 (78)	60 (197)
70	9 (29)	14 (45)	22 (72)	56 (183)
75	8 (27)	13 (42)	20 (67)	52 (171)
80	8 (25)	12 (40)	19 (63)	49 (160)
85	7 (23)	11 (37)	18 (59)	46 (151)
90	7 (22)	11 (35)	17 (56)	43 (142)
95	6 (21)	10 (33)	16 (53)	41 (135)
100	6 (20)	10 (32)	15 (50)	39 (128)

[Note]:

The requirements of diameter apply to single, solid and round cooper wire. The AWG value of multi-stranded wires depends on the total CSA (Cross Sectional Area) of all wires.

Kedacom Two (2) Year Limited Hardware Warranty

WHAT IS COVERED BY THIS WARRANTY?

Kedacom warrants the Kedacom-branded hardware product and accessories contained in the original packaging (hereinafter referred to as "Kedacom Product") against defects in materials and workmanship when used normally in accordance with Kedacom's published guidelines for a period of TWO (2) YEARS from the date of original retail purchase in areas other than mainland China by the end-user purchaser (hereinafter referred to as "Warranty Period"). For the Kedacom Product purchased in mainland China, see the simplified Chinese version of this warranty for details. Kedacom's published guidelines include but are not limited to information contained in technical specifications, user guides, and service communications.

The preceding applies unless otherwise agreed in the contract.

WHAT IS NOT COVERED BY THIS WARRANTY?

This warranty does not apply to any non-Kedacom branded hardware products or any software, even if packaged or sold with Kedacom hardware. Manufacturers, suppliers, or publishers, other than Kedacom, may provide their own warranties to you but Kedacom, in so far as permitted by law, provides their products "AS IS". Software distributed by Kedacom with or without the Kedacom brand (including, but not limited to system software) is not covered by this warranty. Please refer to the licensing agreement accompanying the software for details of your rights with respect to its use. Kedacom does not warrant that the operation of the Kedacom Product will be uninterrupted or error-free. Kedacom is not responsible for damage arising from failures to follow instructions relating to the Kedacom Product's use.

This warranty does not apply: (a) to consumable parts, such as batteries, unless failure has occurred due to a defect in materials or workmanship; (b) to cosmetic damage, including but not limited to scratches, dents, and broken plastic on ports; (c) to damage caused by use with another product; (d) to damage caused by acts outside the control of Kedacom, including without limitation acts of God, accidents, abuse, misuse, fire, storms, earthquakes, flood, or other external cause; (e) to damage caused by exposure of the product to heat, bright light, sun, liquids, sand, or other contaminants; (f) to damage caused by operating the Kedacom Product outside Kedacom's published guidelines; (g) to damage caused by service (including upgrades and expansions) performed by anyone other than a representative of Kedacom, Kedacom employee, or authorized Kedacom agent; (h) to an Kedacom Product that has been modified to alter functionality or capability without the written permission of Kedacom; (i) to defects caused by normal wear and tear or otherwise due to the normal aging of the Kedacom Product, or (j) if any serial number has been removed or defaced from the Kedacom Product.

YOUR RESPONSIBILITIES

If your Kedacom product is capable of storing data and other information, you should make periodic backup copies of the information contained on the storage media to protect the contents and as a precaution against possible operational failures.

Before receiving warranty service, Kedacom or its authorized agents may require that you furnish proof of purchase details, respond to questions designed to assist with diagnosing potential issues, and follow Kedacom's procedures for obtaining warranty service. Before submitting your Kedacom Product for warranty service, you should maintain a separate backup copy of the contents of its storage media, remove all personal information that you want to protect, and disable all security passwords.

During warranty service, it is possible that the contents of the Kedacom product's storage media will be lost, replaced or reformatted. In such an event, Kedacom and its authorized agents are not responsible for any loss of data or other information contained on the storage media or any other part of the Kedacom product serviced.

Following warranty service, your Kedacom Product or a replacement product will be returned to you as your Kedacom Product was configured when originally purchased, subject to applicable updates. You will be responsible for reinstalling all other data and information. Recovery and reinstallation of other data and information are not covered under this warranty.

WHAT WILL KEDACOM DO IF THE WARRANTY IS BREACHED?

If during the Warranty Period, you submit a valid claim to Kedacom or an authorized Kedacom agent, Kedacom will, at its option, (i) repair the Kedacom Product using new or previously used parts that are equivalent to new in performance and reliability, or (ii) exchange the Kedacom Product for a refund of your purchase price.

A Kedacom replacement part or product, including a user-installable Kedacom part that has been installed in accordance with instructions provided by Kedacom, assumes the remaining warranty of the Kedacom Product or ninety (90) days from the date of replacement or repair, whichever provides longer coverage for you. When a product or part is replaced or a refund provided, any replacement item becomes your property and the replaced or refunded item becomes Kedacom's property.

Kedacom reserves the right to refund the purchase price as its exclusive warranty remedy.

HOW TO OBTAIN WARRANTY SERVICE?

To seek warranty service, please contact a local authorized Kedacom agent. When contacting the agent via telephone, other charges may apply depending on your location.

User Information

Complete the form below and keep for ready reference.

User Name:	
Address:	Postal Code:
Tel:	Mobile:
Fax:	E-Mail:
Product Name:	Product Model:
Date of Purchase:	

客户咨询热线：400-828-2866

KEDACOM

苏州科达科技股份有限公司
Suzhou Keda Technology Co.,Ltd.

中国: 江苏省苏州市高新区金山路131号(215011)
Tel: +86-512-6841 8188 Fax: 86-512-68412699

Suzhou Keda Technology Co.,Ltd.

Singapore: 627A Aljunied Road, #09-07, BizTech Centre, Singapore 389842

Tel: +65-6842-5700 Fax: +65-6842-5900

05.03.800921 (V3.2) 20200430